

P-1100 / 1200 法蘭式撓性接頭



FLEXIBLE CONNECTOR WITH STEEL FLANGE ENDS

※ 結構組合 (CONSTRUCTION)

項次 Item	配件名稱 Parts	標準材料 Std. Material	選用材料 Option Material
1.	法蘭 (FLANGE)	SS-400	SUS-304 / SUS-316
2.	束環 (COLLAR RING)	SUS-304	-
3.	波紋管 (BELLWS)	SUS-304	SUS-316L / 321
4.*	編織網 (WIRE BRAIDS)	SUS-304	-

法蘭標準規格 (Flange Standard) : JIS-10K
其餘規格亦可依實際需求選用, 如ANSI, DIN, BS ...等。
Other standard flanges are available, like ANSI, DIN, BS ...etc.

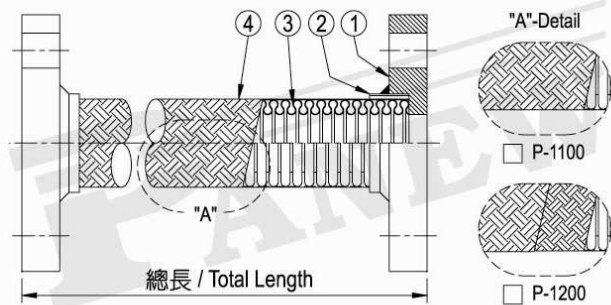

※ P-1100 規格說明 / STANDARD SPECIFICATION

公稱軟管管徑 Nominal Hose I.D.		產品總長 Total Length		軟管規格 / Hose Specification			允許之側向位移 Allowable Movement		操作壓力 working pressure	單位重量 unit weight (JIS-10K)
				外徑 O.D.	波紋管型式 Bellows Type	網材型式 Braids Type	Vibration	Static		
mm	inch	mm	inch	mm	H / A	S / D	mm	mm	kg/cm ²	kg/set
32	1 ¹ / ₄	200	8	45.5	A	S	27.6	39.6	35.0	3.2
40	1 ¹ / ₂	200	8	55.5	A	S	20.5	31.2	29.5	3.4
50	2	230	9	69.5	A	S	29.1	41.8	20.5	4.1
65	2 ¹ / ₂	230	9	84.0	A	S	23.8	34.0	16.5	5.7
80	3	230	9	98.0	A	S	21.9	30.2	13.0	5.8
100	4	230	9	124.5	A	S	17.6	24.3	12.5	7.0
125	5	280	11	152.0	A	S	20.7	29.2	11.0	10.9
150	6	280	11	178.5	A	S	17.4	24.3	9.5	14.3
200	8	300	12	231.0	A	S	15.7	22.3	10.0	17.9
250	10	330	13	283.0	A	S	17.3	24.0	8.0	27.8
300	12	350	14	334.0	A	S	13.3	19.5	6.5	31.8
350	14	350	14	372.0	A	S	12.2	17.7	6.0	39.8
400	16	400	16	420.0	A	S	14.7	21.2	5.5	56.5

※ P-1100B 規格說明 / STANDARD SPECIFICATION

公稱軟管管徑 Nominal Hose I.D.		產品總長 Total Length		軟管規格 / Hose Specification			允許之側向位移 Allowable Movement		操作壓力 working pressure	單位重量 unit weight (JIS-16K)
				外徑 O.D.	波紋管型式 Bellows Type	網材型式 Braids Type	Vibration	Static		
mm	inch	mm	inch	mm	H / A	B-B	mm	mm	kg/cm ²	kg/set
250	10	330	13	283.0	A	B-B	15.0	20.8	10.0	28.3
300	12	350	14	334.0	A	B-B	11.6	16.9	10.0	32.2
350	14	350	14	372.0	A	B-B	10.6	15.3	11.0	43.0
400	16	400	16	420.0	A	B-B	12.7	18.4	8.5	60.2

※ P-1200 規格說明 / STANDARD SPECIFICATION

公稱軟管管徑 Nominal Hose I.D.		產品總長 Total Length		軟管規格 / Hose Specification			允許之側向位移 Allowable Movement		操作壓力 working pressure	單位重量 unit weight (JIS-16K)
				外徑 O.D.	波紋管型式 Bellows Type	網材型式 Braids Type	Vibration	Static		
mm	inch	mm	inch	mm	H / A	S / D	mm	mm	kg/cm ²	kg/set
65	2 ¹ / ₂	230	9	84.0	A	D	18.3	26.1	26.5	5.6
80	3	230	9	98.0	A	D	15.9	21.9	21.0	7.6
100	4	230	9	124.5	A	D	12.3	16.8	20.0	10.0
125	5	280	11	152.0	A	D	15.3	21.6	18.0	15.0
150	6	280	11	178.5	A	D	12.8	17.8	15.5	19.4
200	8	300	12	231.0	A	D	11.3	15.9	16.0	25.3
250	10	330	13	283.0	A	D	12.5	17.3	13.0	41.4
300	12	350	14	334.0	A	D	9.3	13.7	10.5	51.4
350	14	350	14	372.0	A	D	8.3	12.0	10.0	70.5
400	16	400	16	420.0	A	D	9.9	14.3	9.0	97.7

※ P-1200B 規格說明 / STANDARD SPECIFICATION

公稱軟管管徑 Nominal Hose I.D.		產品總長 Total Length		軟管規格 / Hose Specification			允許之側向位移 Allowable Movement		操作壓力 working pressure	單位重量 unit weight (JIS-16K)
				外徑 O.D.	波紋管型式 Bellows Type	網材型式 Braids Type	Vibration	Static		
mm	inch	mm	inch	mm	H / A	D(B-B)	mm	mm	kg/cm ²	kg/set
250	10	330	13	283.0	A	D(B-B)	10.8	15.0	16.0	42.3
300	12	350	14	334.0	A	D(B-B)	8.1	11.9	16.0	52.7
350	14	350	14	372.0	A	D(B-B)	7.2	10.4	18.0	75.2
400	16	400	16	420.0	A	D(B-B)	8.6	12.4	14.0	102.9

上表所示操作壓力以常溫25°C為基準, 其最小爆破壓力為4倍之操作壓力值。

The working pressure tabulated above is based on the room temperature (about 25°C) and minimum burst pressure is 4 times the working pressure.

上表所示口徑 / 操作壓力 / 總長 / 作動量均為標準規格, 本公司亦可依客戶實際需求訂製。

The size, working pressure, total length, and movement tabulated above is the standard products. We can also deliver products against your requests.

P-3200 軸向式伸縮接頭



AXIAL / SINGLE EXPANSION JOINT

□ P-3200 性能規格表 / Specification

公稱管徑 N.D.		# 產品總長 Total Length (L)		波紋管規格 (Bellows Specification)				軸向變位(Axial Movement)		操作壓力 working pressure	單品重量 Weight/pc (JIS-16K)
				有效長度 Eff. Length	外徑 O.D.	有效面積 Eff. Area	彈性係數 Spring Rate	伸張 Extension	壓縮 Compression		
mm	inch	mm	inch	Lb (mm)	Φ D (mm)	cm ²	kg/mm	Δ Xe(mm)	Δ Xc(mm)	kg/cm ²	kg/pc
32	1-1/4	200	8	88	59.2	20.0	19.7	5	30	16	4.9
40	1-1/2	250	10	96	65.7	25.4	20.3	5	30	16	5.4
50	2	300	12	120	81.4	38.7	25.0	5	35	16	6.5
65	2-1/2	300	12	120	97.2	58.4	30.8	5	35	16	8.8
80	3	300	12	120	113.7	79.6	26.0	10	40	16	11.3
100	4	300	12	132	139.7	126.1	29.6	10	45	16	14.6
125	5	300	12	144	165.7	183.1	32.6	10	45	16	19.9
150	6	350	14	165	196.7	255.9	37.5	10	50	16	27.6
200	8	350	14	180	247.7	420.9	43.8	10	55	16	37.6
250	10	350	14	220	305.7	643.6	57.0	10	60	16	55.7
300	12	350	14	220	355.5	887.1	66.2	10	60	16	68.1
350	14	400	16	200	399.0	1119.7	61.8	10	65	16	90.7
400	16	400	16	200	458.7	1464.9	93.6	10	65	16	135.3
450	18	400	16	210	500.0	1720.2	90.1	10	70	16	164.7
500	20	400	16	210	551.0	2115.6	99.3	10	70	16	192.2
550	22	400	16	210	602.0	2551.8	109.1	10	70	16	223.1
600	24	400	16	210	653.0	3028.8	119.0	10	70	16	244.4

#上表所示口徑 / 操作壓力 / 總長 / 作動量均為標準規格，本公司亦可依客戶實際需求訂製。

The size, working pressure, total length, and movement tabulated above is the standard specification. We can also deliver products against your requests.

#上表所示工作壓力以溫度100°C為基準，其最大使用壓力為 1.5 倍之工作壓力值。

The working pressure tabulated above is based on 100°C. The maximum operating pressure is 1.5 times the working pressure tabulated above.

#上表所示產品重量，均以 JIS-16K 為準，如需其它規格重量或相關資料，請隨時與我們聯絡。

The unit weight of the products tabulated above are based on JIS-16K flanges. If you need more information, please feel free to contact us any time.

□ 其它型式外型規格說明 / Profile specifications of other types

※結構組合 / Construction

項次 Item	配件名稱 Parts	標準材質 Std. Material	選用材質 Option Material
1.	法蘭 (Flange)	SS-400	SUS-304/316
2.	端管 (End Pipe)	SGP/SS-400	SUS-304/316
3.	波紋管 (Bellows)	SUS-304	SUS-316
4.	內套管 (Sleeve)	SUS-304	SUS-316
5.	固定螺桿 (Shipping Rod)	S-15C	SUS-304
6.	鐸耳 (Lug)	SS-400	SUS-304
7.	外筒 (Cover)	SS-400	SUS-304

型號說明：

(Model No. Instruction)

P - 3 X X X

0. 法蘭碳鋼材質
(Flange C.S. Material)
5. 法蘭不鏽鋼材質
(Flange S.S. Material)

如下圖 (as figures below)
0 : 10 kg/cm² / 2 : 16 kg/cm²

軸向伸縮接頭
(Axial Expansion Joint)

聯宇公司 (Panew Company)

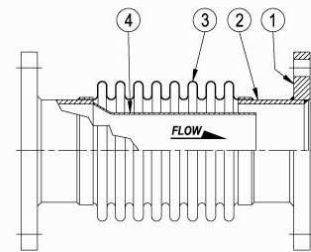

□ P-3010 □ P-3210

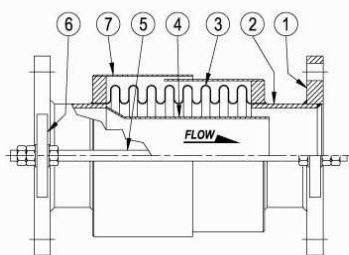

□ P-3020 □ P-3220

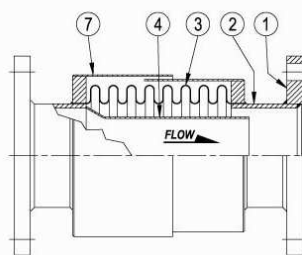

□ P-3030 □ P-3230

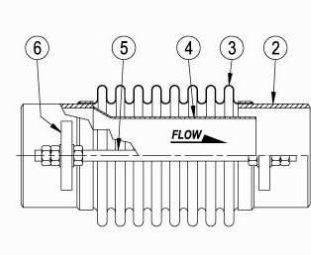

□ P-3050 □ P-3250

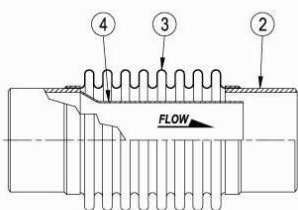

□ P-3060 □ P-3260

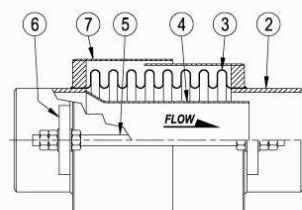

□ P-3070 □ P-3270

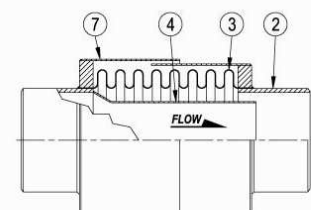

□ P-3080 □ P-3280